

STAR TREK

THE ORIGINAL SERIES

DPH81

TRANSPORTER ROOM
SALLE DE TÉLÉPORTATION
SALA DE TRANSPORTACIÓN
SALA DE TRANSPORTAÇÃO
SALA DEL TELETRASPORTO
TRANSPORTERRAUM
POMIESZCZENIE TRANSPORTERA
TRANSPORTRUIMTE
ТРАНСПОРТАТОР



**MEGA
BLOKS**

- 1x AM76713W
- 1x AM76713F
- 3x MA03328F
- 2x AM18286F
- 1x MA1086F
- 2x AM77619ALG
- 1x MA022501F
- 2x MA07590BDG
- 27x MA09393F
- 1x AM76467BLG
- 2x AM76467F
- 1x AM18272BLG

- 1x MA18549BLG
- 1x AS-DPH81-02
- 1x AS-DPH81-06
- 8x AM76559F
- 8x AM76560F
- 2x MA04429BLG
- 8x MA04429F
- 8x MA17502F
- 6x MA17502BLG
- 3x MA09013BLG
- 1x AM04322F
- 2x AM04322AMC

- 2x MA15484F
- 1x MA03484BDG
- 1x MA03485BDG
- 1x MA0948F
- 1x AS-DPH81-04
- 1x MA03773BLG
- 1x MA17153BLG
- 10x MA17153F
- 2x MA09023F
- 1x MA1314AMC
- 10x MA1314F

- 1x MA16384F
- 1x MA16384BLG
- 1x AS-DPH81-05
- 1x AS-DPH81-03
- 2x MA03873F
- 4x MA09838F
- 2x M09838KC
- 11x MA09593AMC
- 1x MA09593BDG
- 2x MA09593BLG
- 12x MA09593F

- 7x MA1087BLG
- 6x MA1087F
- 1x MA17503BLG
- 4x MA17503F
- 3x AM77622ATH
- 5x AM77622AWB
- 1x AM72904AWB
- 5x AM72904KC
- 1x MA09493BDG
- 3x MA09493F

- 7x MA09033F
- 1x MA09033BLG
- 6x AM09239BLG
- 6x AS-DPH81-01
- 2x AS-DPH81-07

- 2x AM17793KC
- 3x MA07475AMC
- 5x AM17148F
- 1x MA17054F
- 1x AS-DPH81-08
- 6x M16331KC
- 1x MA09292AMC
- 1x MA09292BDG
- 3x MA09292BLG
- 7x MA1313BLG
- 1x MA1313F



SPOCK



- 1x
MA1480F
- 1x
MA1480BDG
- 1x
MA1480AMC
- 1x
MA1480BLG
- 1x
MA17055BDG
- 6x
MA09922F
- 1x
MA08483BDG
- 2x
MA08483F

- 4x
AM17077AMC
- 4x
AM17076AMC
- 1x
MA17845BDG
- 2x
MA17845AMC
- 1x
MA09923BDG
- 1x
MA74678BDG
- 1x
AM15476BDG

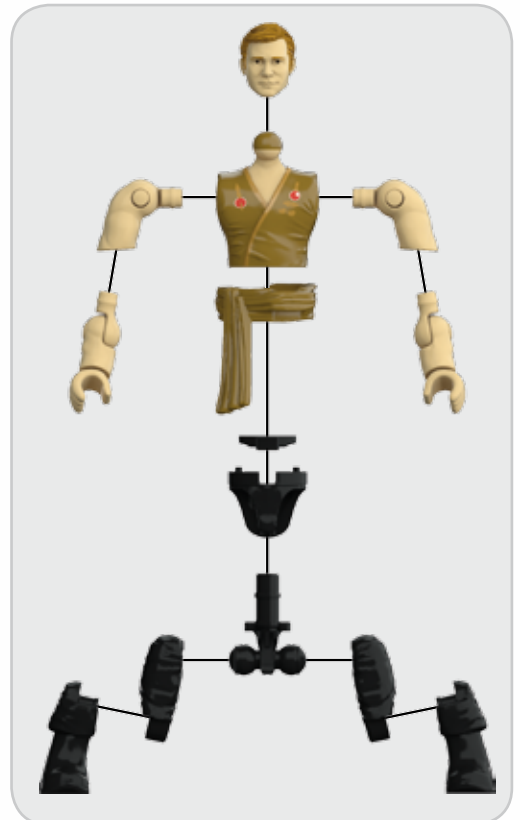
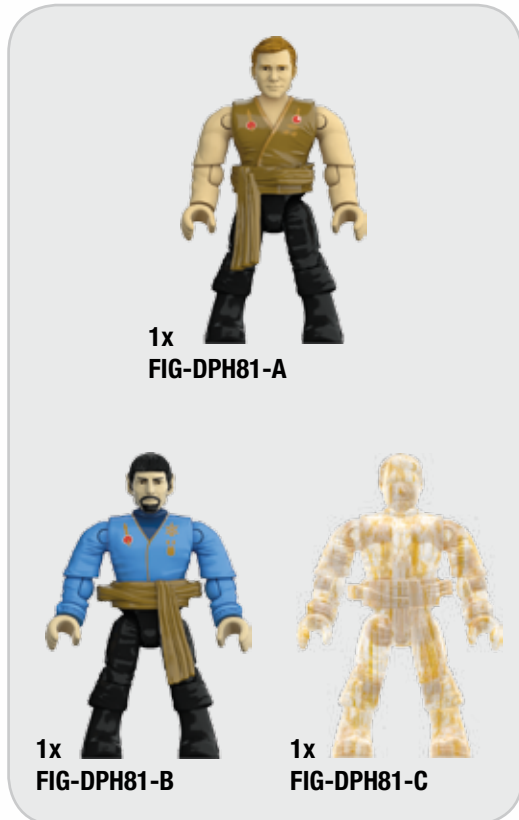

Please read these instructions carefully before first use and keep them for future reference.
 Il est recommandé de lire attentivement ce feuillet avant la première utilisation et de le conserver pour référence future.
 Leer estas instrucciones cuidadosamente antes de la primera utilización y guardarlas para referencia futura.
 Leia as instruções antes do primeiro uso e guarde-as para futura referência.
 Leggere le istruzioni prima di cominciare ad usare il gioco e conservarle per referenze future.
 Die Gebrauchsanleitung bitte durchlesen und aufbewahren.
 Proszę uważnie przeczytać instrukcję obsługi przed pierwszym użyciem, a następnie zachować ją na przyszłość.
 Wij raden u aan deze handleiding zorgvuldig te lezen en te bewaren voor eventuele raadpleging op een later tijdstip.
 Внимательно прочитайте инструкцию перед первым использованием и сохраните ее для дальнейшего использования.
 Vær venlig at læse disse instruktioner omhyggeligt inden ibrugtagen og opbevar dem til fremtidigt brug.
 Läs noggrant igenom dessa instruktioner innan du använder produkten för första gången och spara dem för ev. framtida frågor.
 Les disse instruksjonene nøye før første gangs bruk, og ta vare på dem for fremtidige oppslag.
 Lue nämä ohjeet huolellisesti ennen ensimmäistä käyttöä ja säilytä ne myöhempää tarvetta varten.
 Διαβάστε αυτές τις οδηγίες προσεκτικά πριν χρησιμοποιήσετε το προϊόν για πρώτη φορά και φυλάξτε τις για μελλοντική αναφορά.
 يرجى قراءة هذه التعليمات بدقة قبل البدء بالاستعمال والاحتفاظ بها كمرجع للمستقبل
 请在初次使用前仔细阅读这些指示，并保留它们以便未来参考。
 初めてご使用になる前に、この説明書をよくお読みください。また、本書は将来いつでも参照できるように保管してください。

© D714,887

TM & © 2016 CBS Studios Inc. STAR TREK and related marks and logos are trademarks of CBS Studios Inc. All Rights Reserved.



JAMES T. KIRK

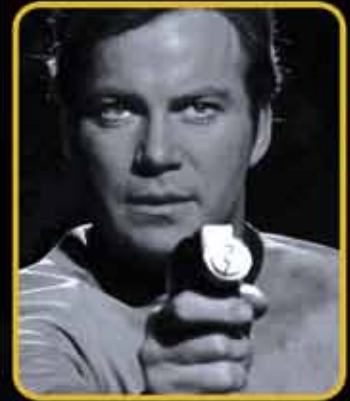

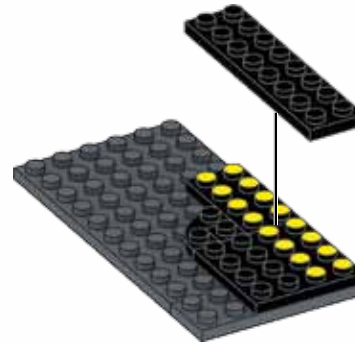
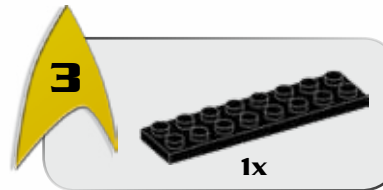
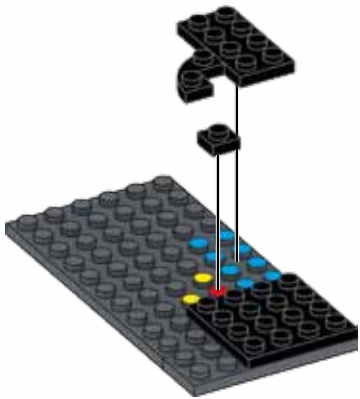
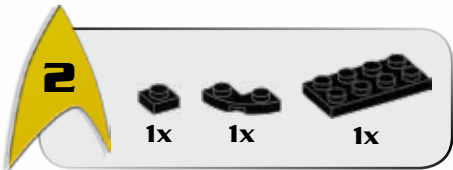
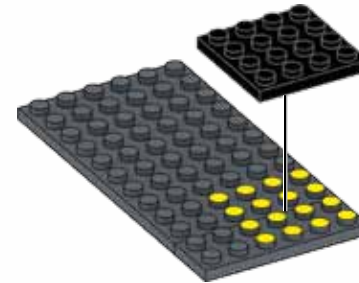
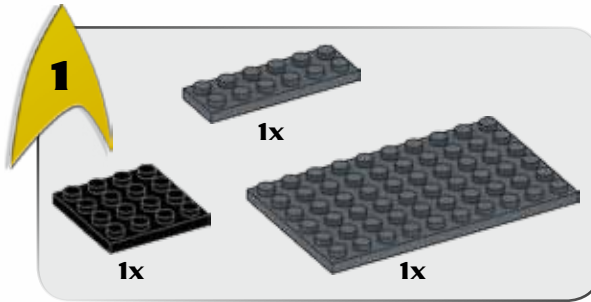

1



2

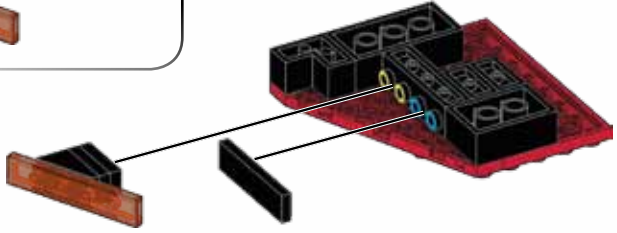
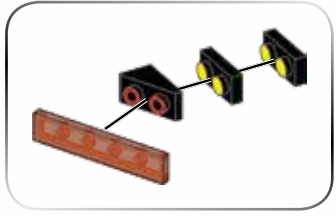
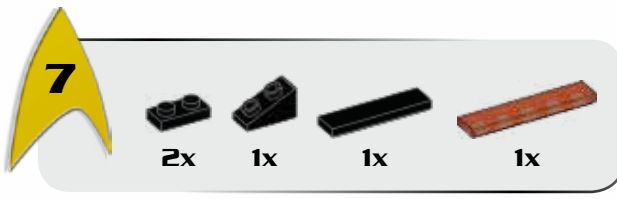
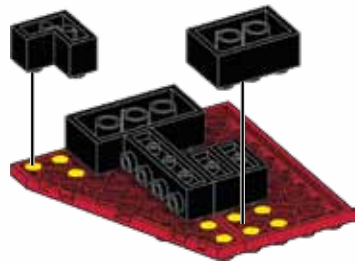
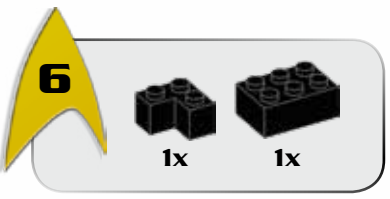
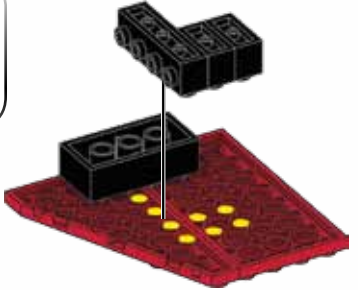
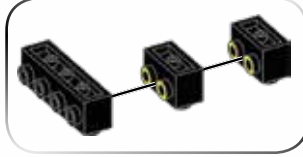
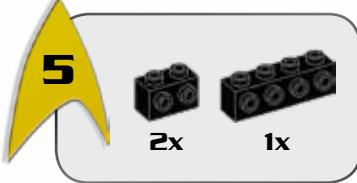
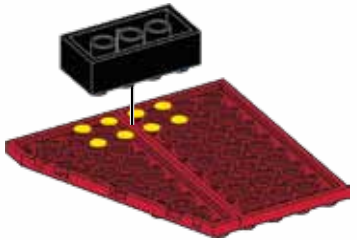
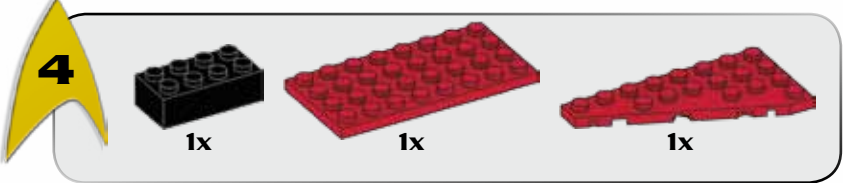

1



2

8

3

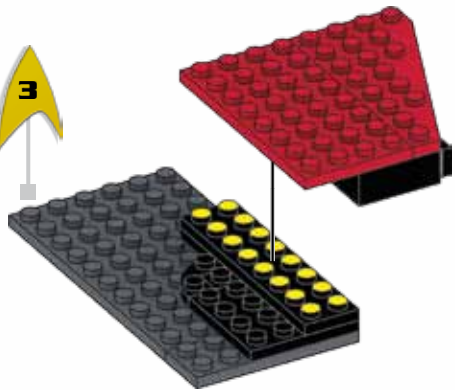

9

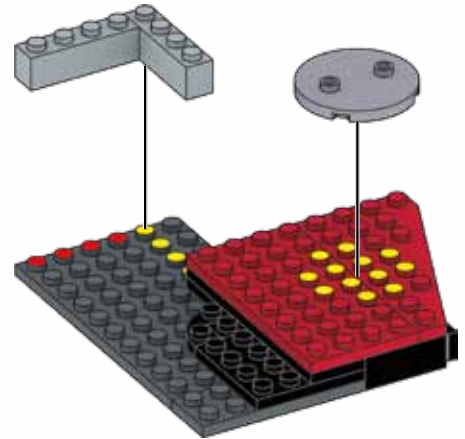
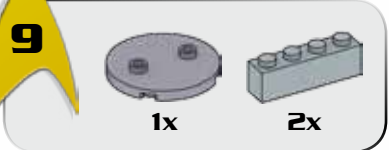

10

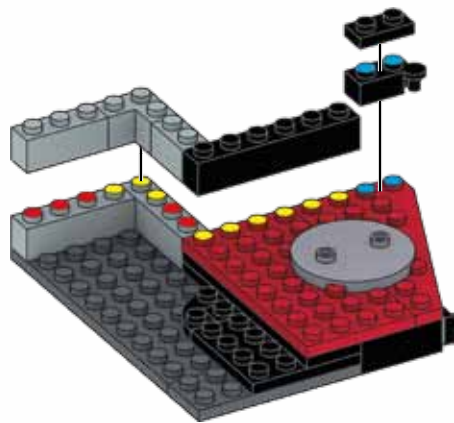

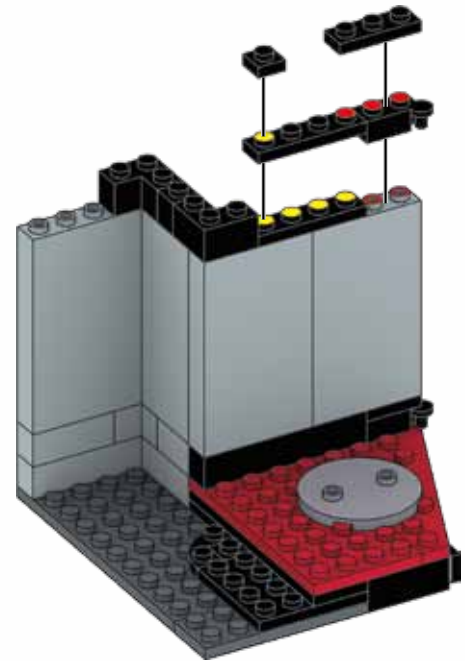
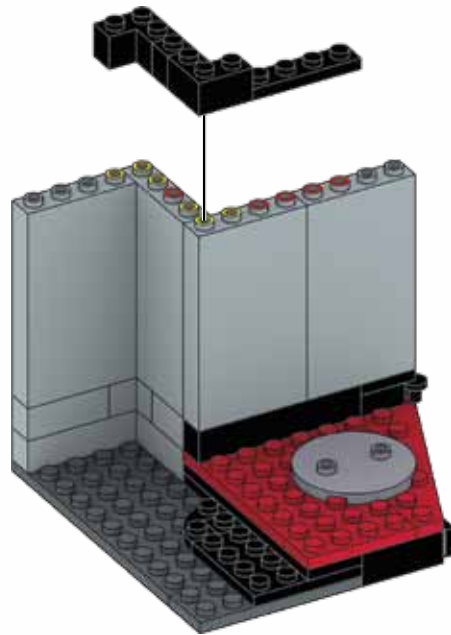
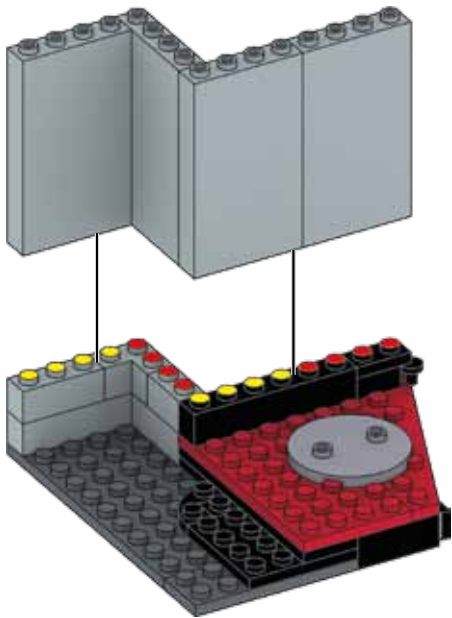
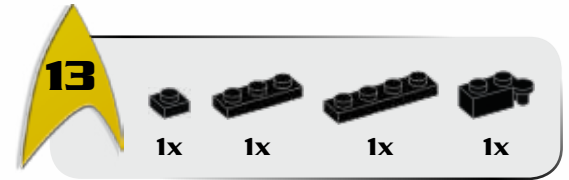
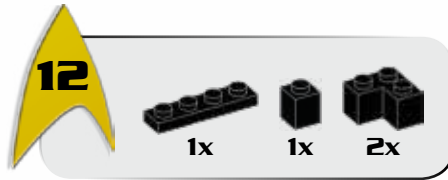
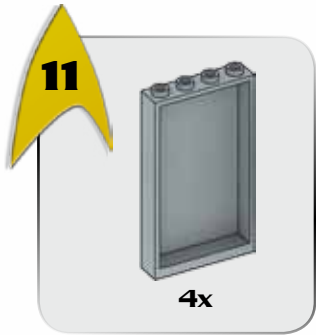

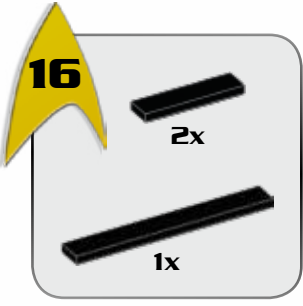
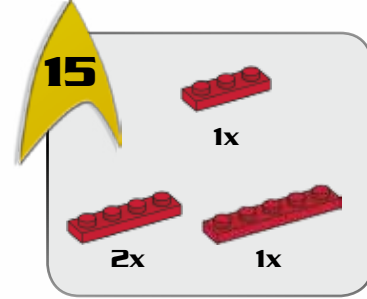
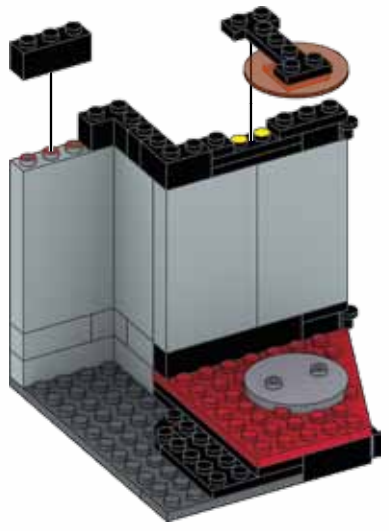
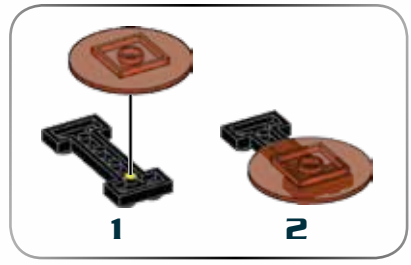
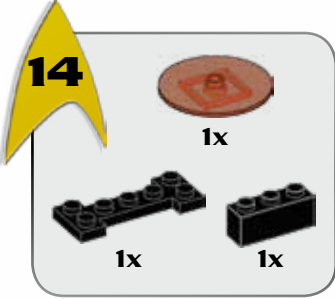



17

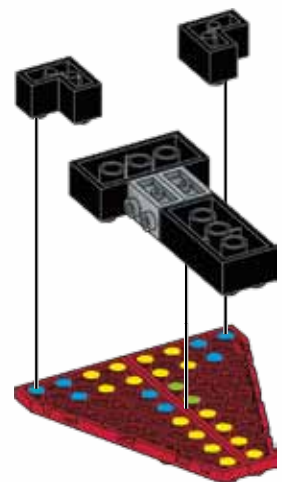
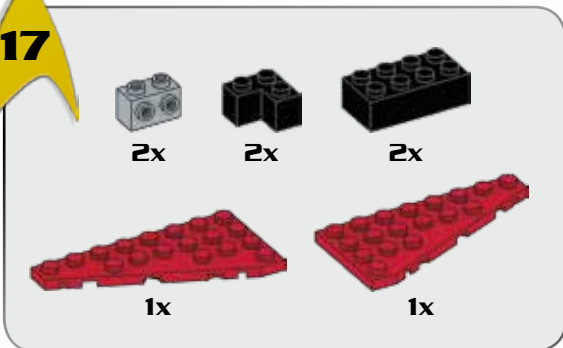

18

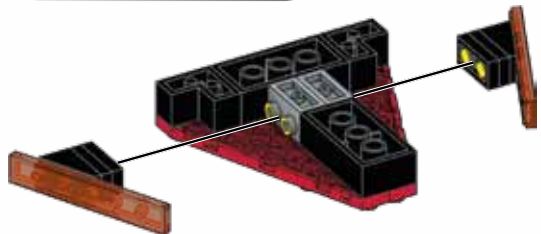
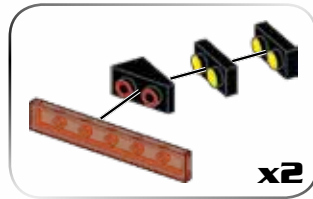

1



2

19

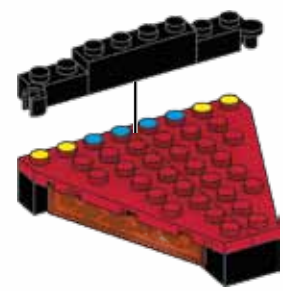

20

2x 1x

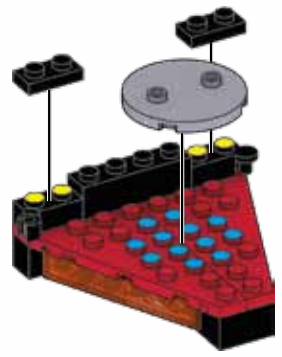

21

1x 1x

or/ou
oder
of/lub/Или

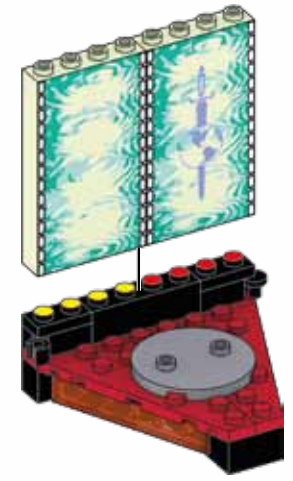

22

1x



23

1x 1x
2x 1x



24



1x



1x



1



2



25



2x



1x



1



2



26

- 3x [Black 1x2 Technic Brick]
- 2x [Grey 1x2 Technic Brick]
- 2x [Black 1x2 Technic Brick]
- 1x [Black 1x4 Technic Brick]
- 1x [Red 1x6 Technic Plate]
- 1x [Red 1x6 Technic Plate]

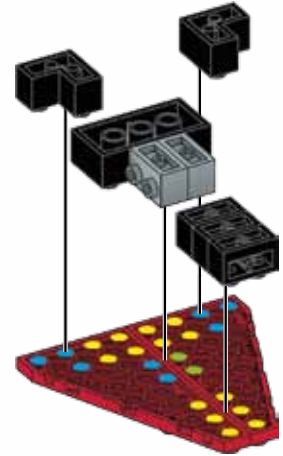

27

- 4x [Black 1x2 Technic Brick]
- 2x [Black 1x2 Technic Brick]
- 2x [Red 1x6 Technic Plate]

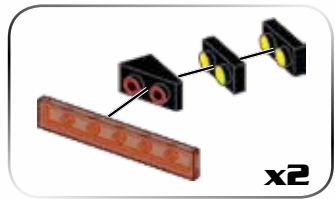

28

- 1x [Black 1x2 Technic Brick]
- 1x [Black 1x2 Technic Brick]
- 1x [Black 1x4 Technic Brick]

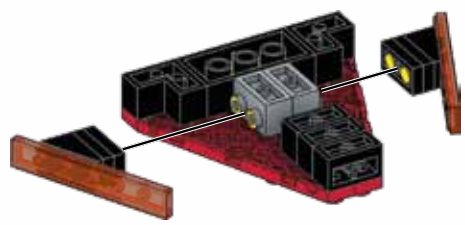

29
2x
1x

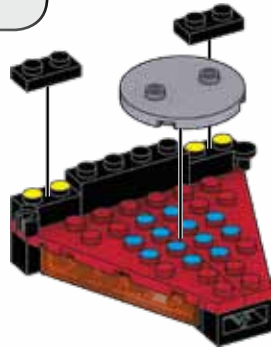

30
2x

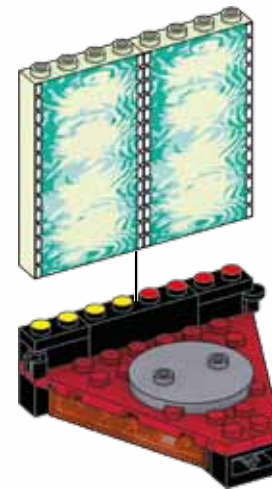

31
1x



32
1x 1x
2x 1x



33



1x



1x



1



2



34



2x



1x



1



2



35

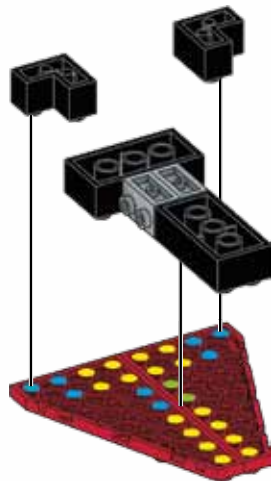
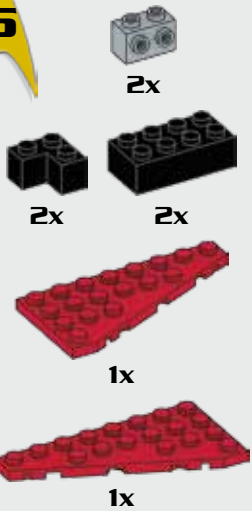

36

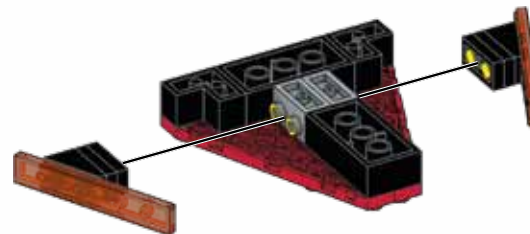

1

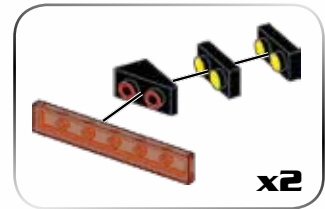

x2



2

37

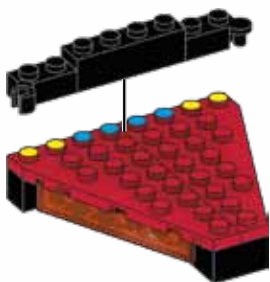
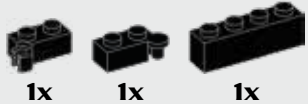

38

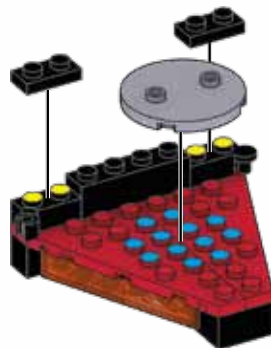

39

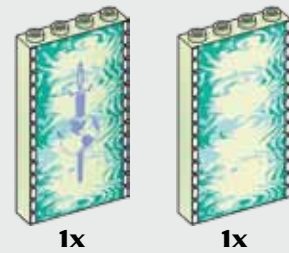

1x

1x



or/ou
oder
of/ub/Млн

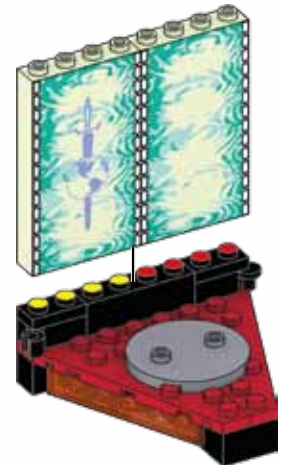

40
1x



41
1x 1x
2x 1x



42
1x 1x



1 2

43
2x 1x

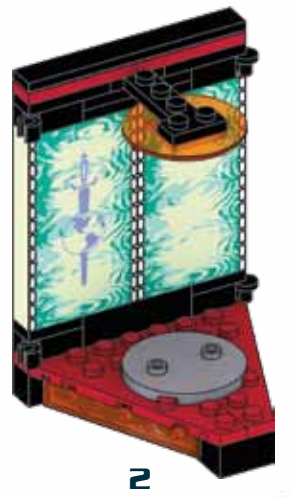

1

2



44

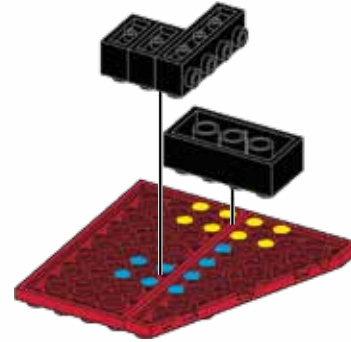
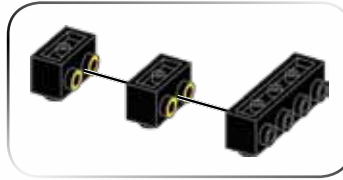
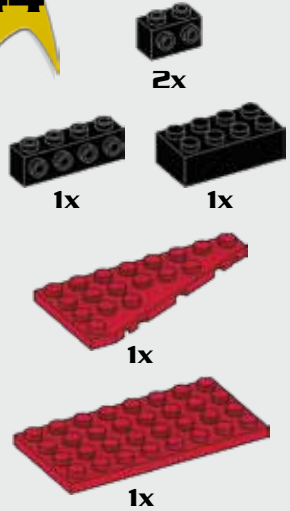

45

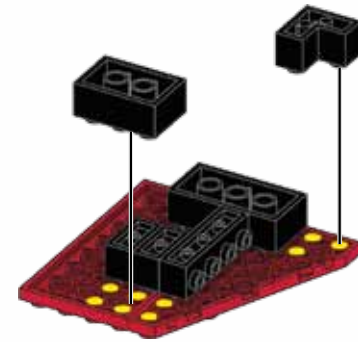
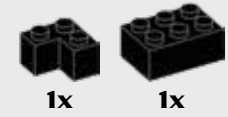

46

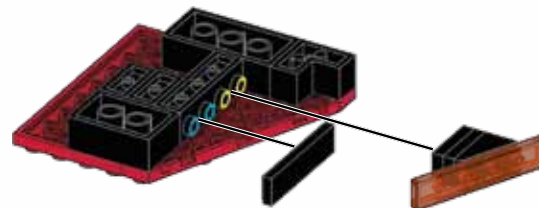
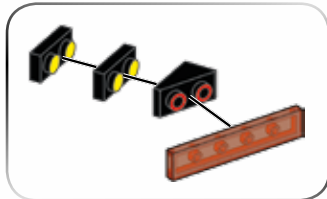
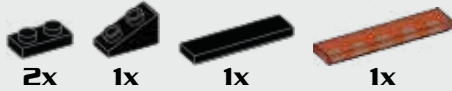

1



2

47

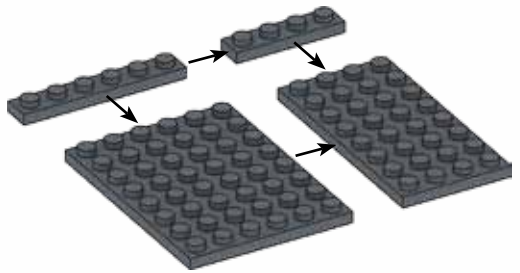
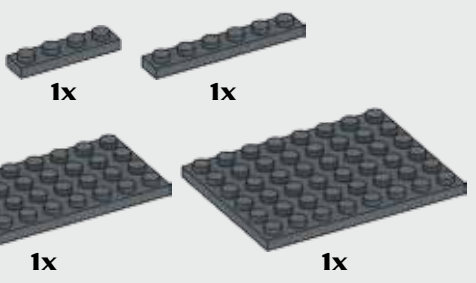

48

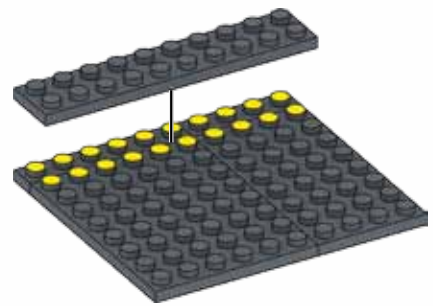
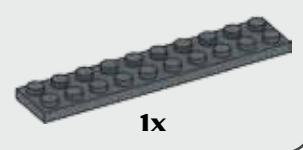

49

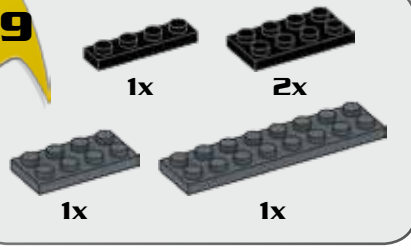

50

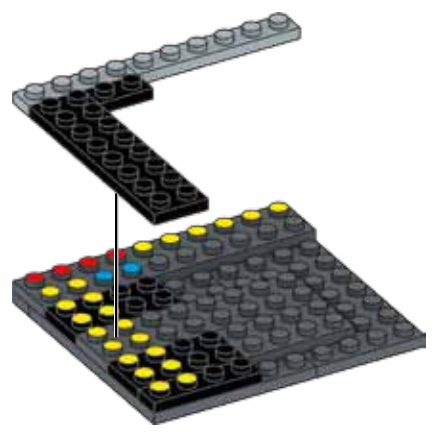
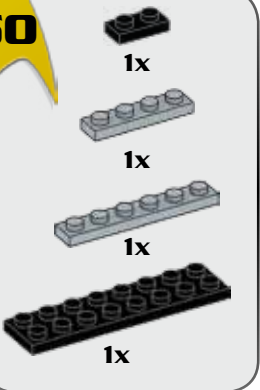

51

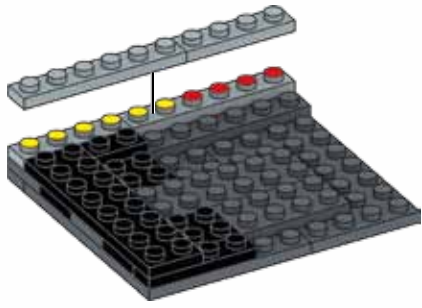
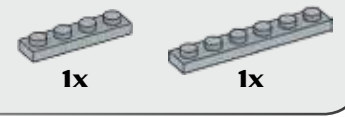

1



2

52

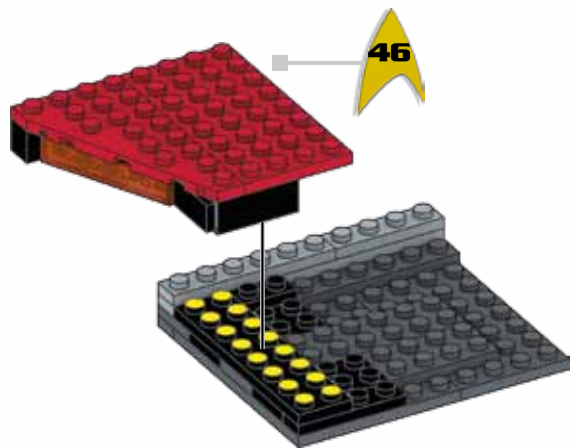

53

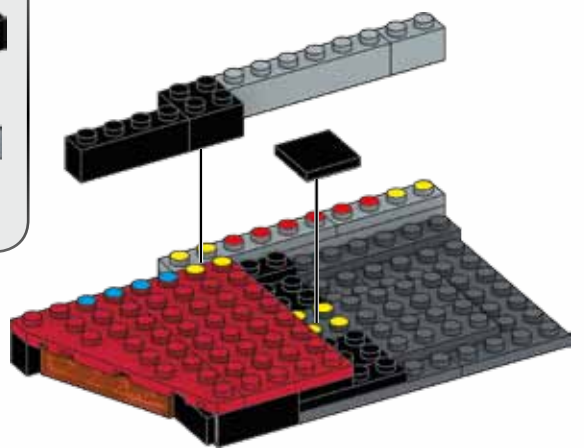
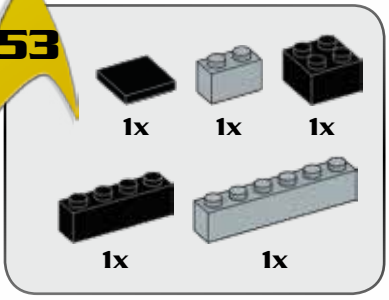

54

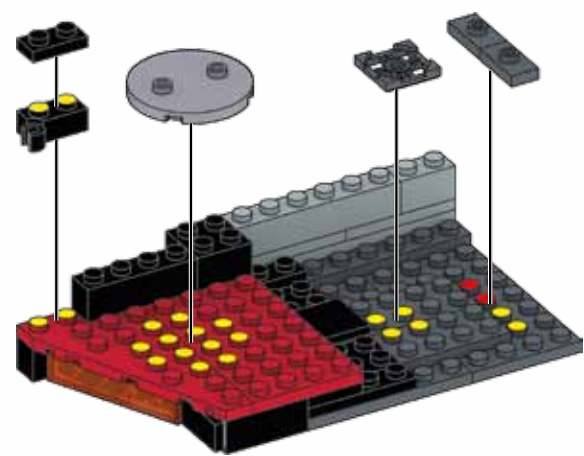

55

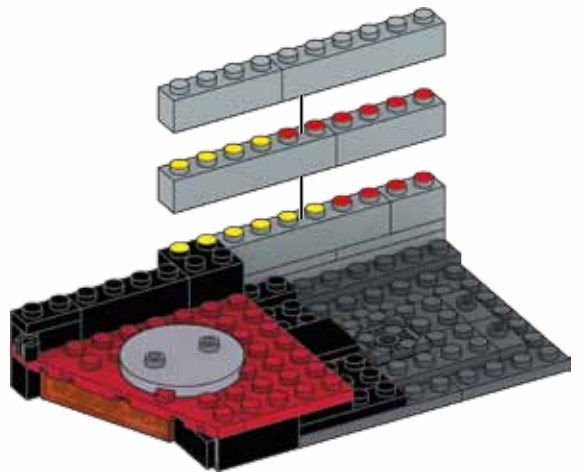
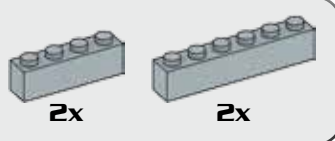

56

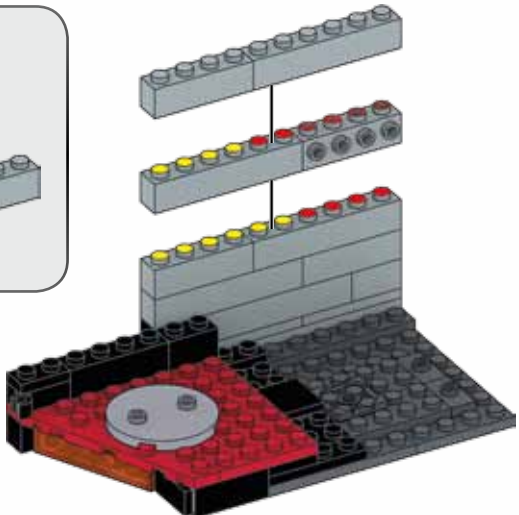
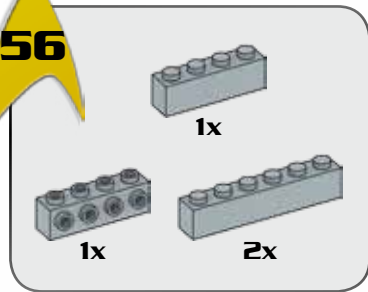

57

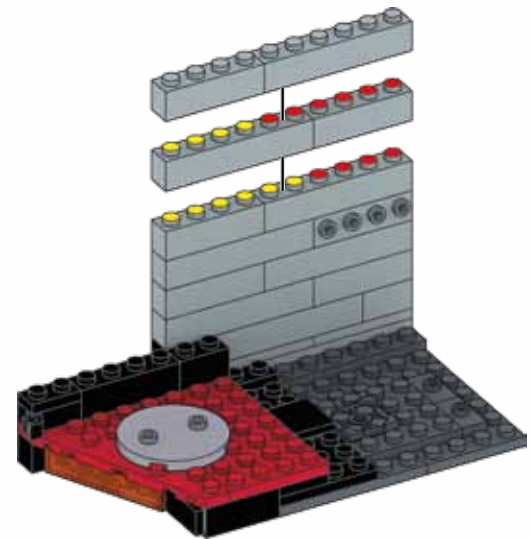
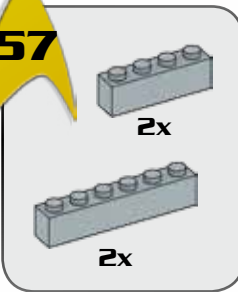

58

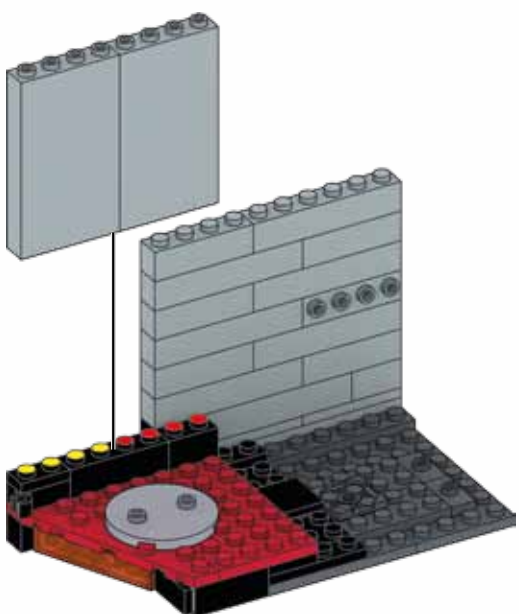

59

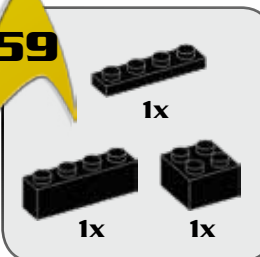

60



61

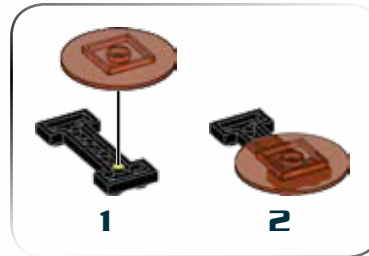
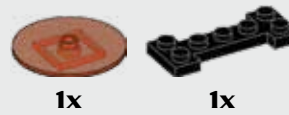

62



63

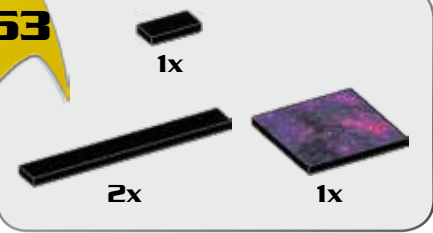

1



2

64

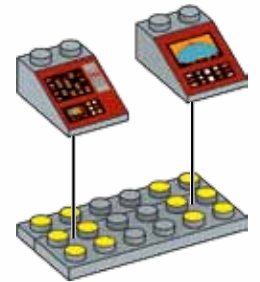
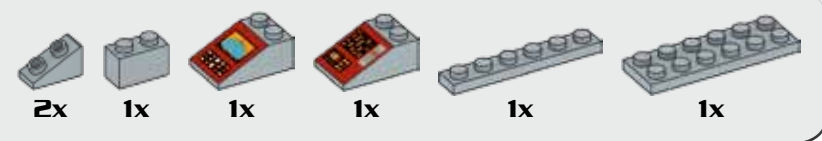

1

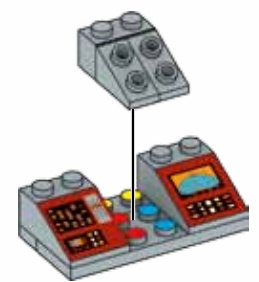

2

65



1



2



3

66

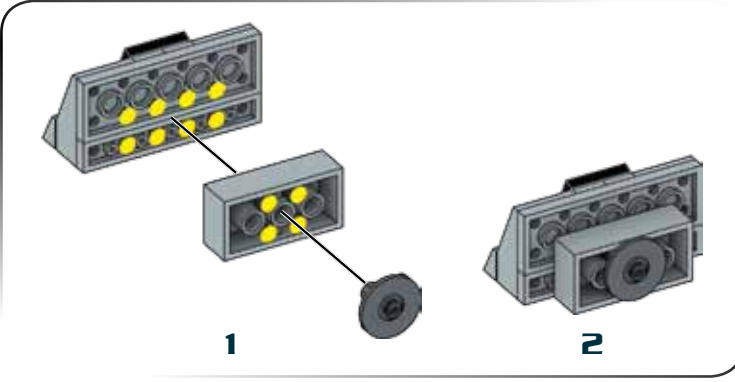
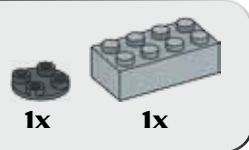

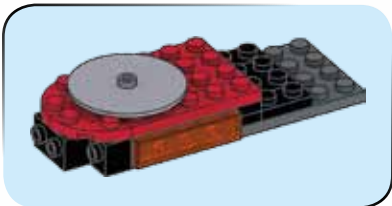

67

2x 1x 1x



68

2x 2x

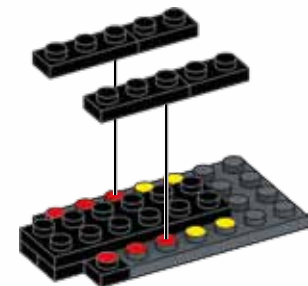

69

1x 1x

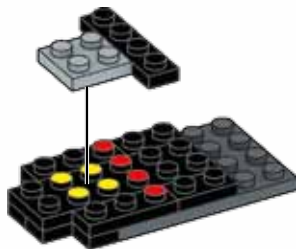

70

1x 2x

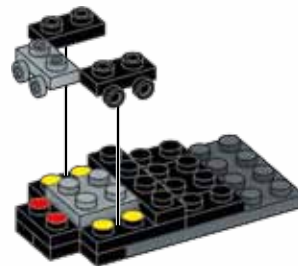

1



2

75

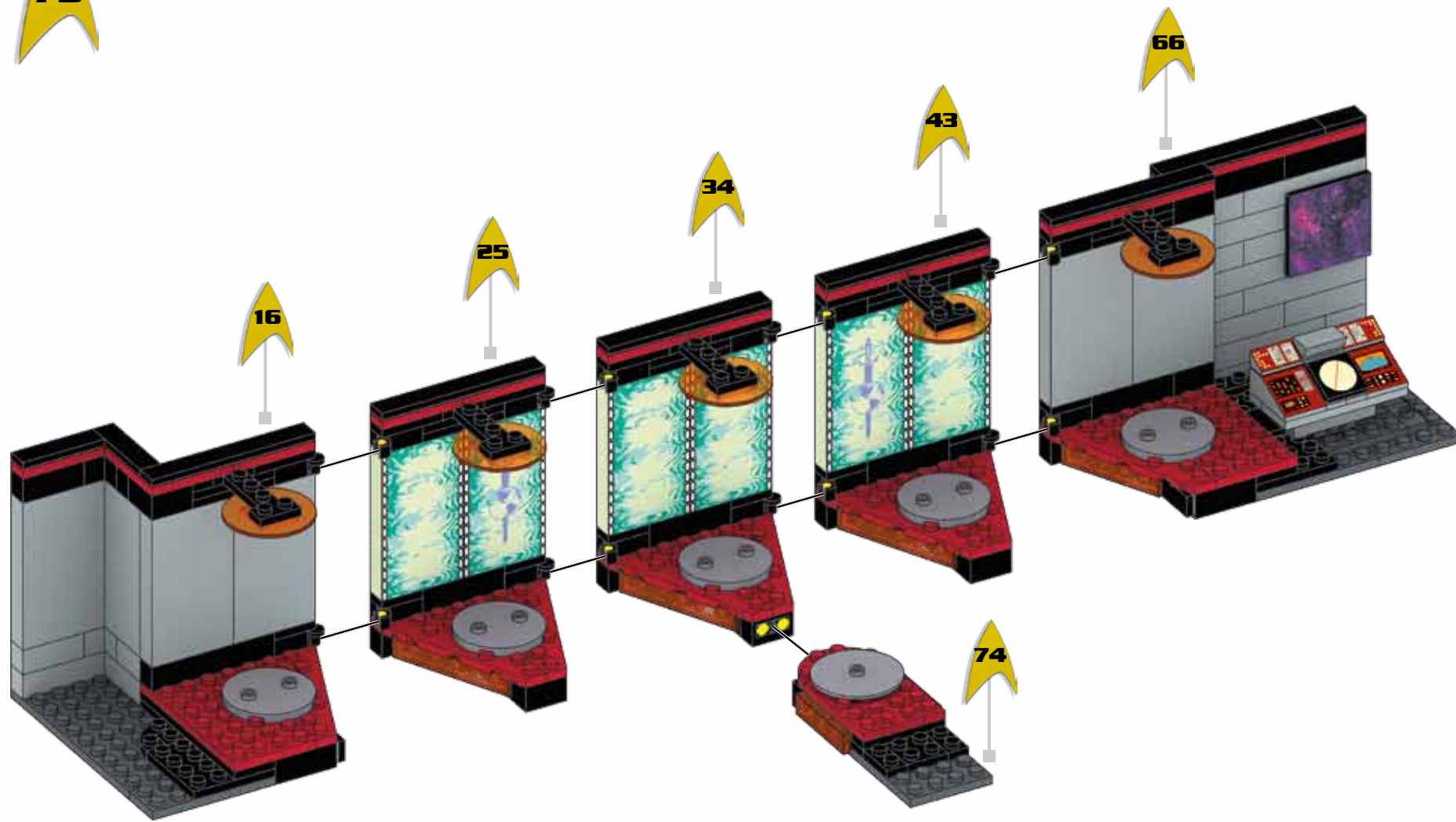

76

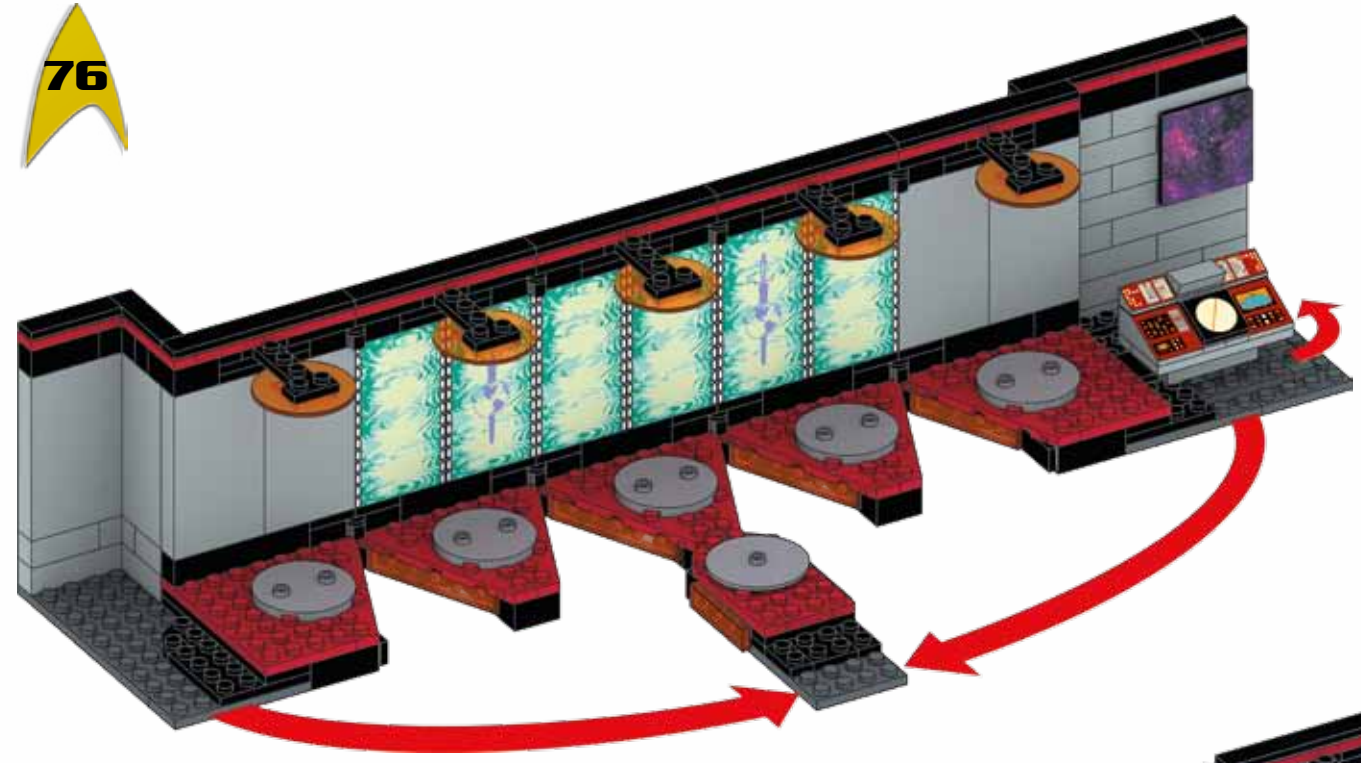

1



2



STAR TREK

THE ORIGINAL SERIES



BUILD THE VOYAGE! • CONSTRUIS L'AVENTURE DU RETOUR! • ¡CONSTRUYE LA MISIÓN! • CONSTRÓI A VIAGEM!
COSTRUISCI IL VIAGGIO NELLO SPAZIO! • BAUE DIE VOYAGER! • ZBUDUJ WŁASNĄ PRZYGODĘ! • BOUW DE REIS!
ПОСТРОЙ ЗВЕЗДНЫЙ ПУТЬ!



DPH83



DPH82



DPH80



DPY05



DPH79

Each sold separately and subject to availability. / Tous vendus séparément. Certains produits peuvent ne pas être commercialisés. / Se venden por separado y están sujetos a disponibilidad. / Vendidos em separado e sujeitos à disponibilidade. / Ognuno in vendita separatamente secondo disponibilità. / Alle Artikel separat erhältlich. Einige Artikel werden nicht in allen Ländern vertrieben. / Sprzedawane oddzielnie w zależności od dostępności. / Per stuk verkrijgbaar en niet overal leverbaar. / Каждый продукт продается отдельно, в зависимости от наличия. / Sælges separat og så længe lager haves. / Alla delar säljs separat så långt lagret räcker. / Hver leke selges separat så langt lageret rekker. / Jokainen myydään erikseen, saatavuus voi vaihdella. / Το καθένα πωλείται ξεχωριστά και ανάλογα με τη διαθεσιμότητα. /

تباع كل منها على حدة وتخضع لتوفرها.
每件单独出售，并且视库存情况而定。
それぞれ在庫状況に従って個別に販売されます。



STARTREK.MEGABLOKS.COM

